

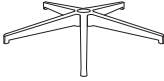

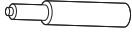

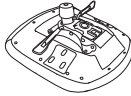









Assembling Instruction

Ax1 	Bx1 	Cx1 	Dx1 	E(R,L)x1 R  L 	Fx1 	Gx5 	Hx1 
Ix4  6X30mm	Jx6  6X50mm	Kx2  6X30mm	Lx6  6X13mm	Mx4  6X16mm	Nx1  5mm	Ox1  4mm	



The angle and height of headrest is adjustable.

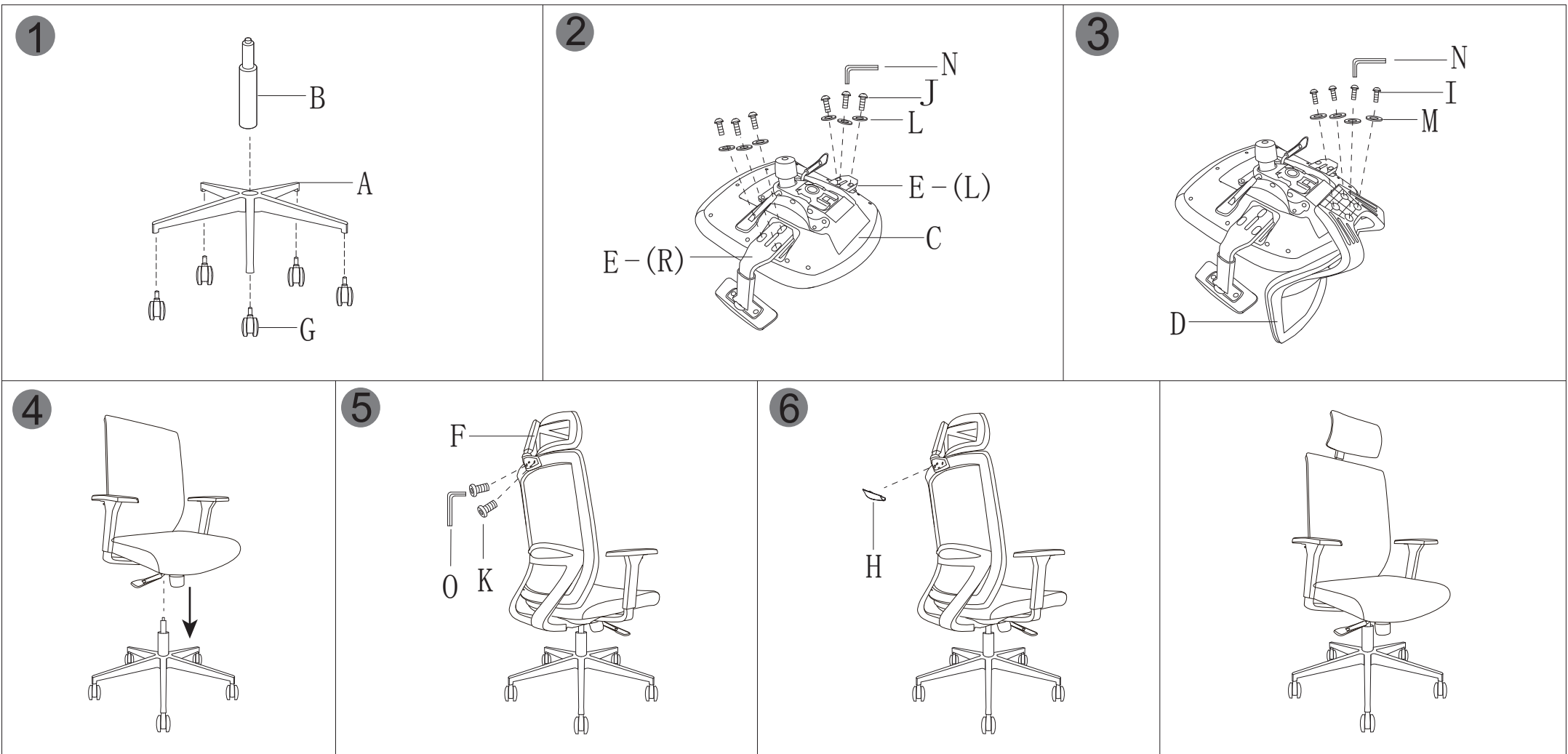
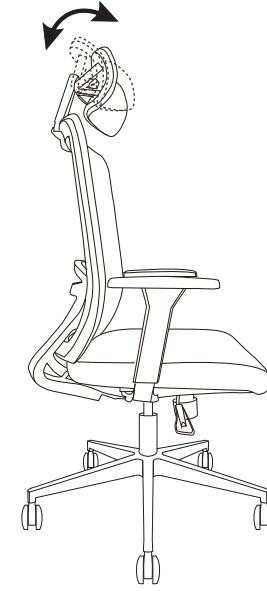
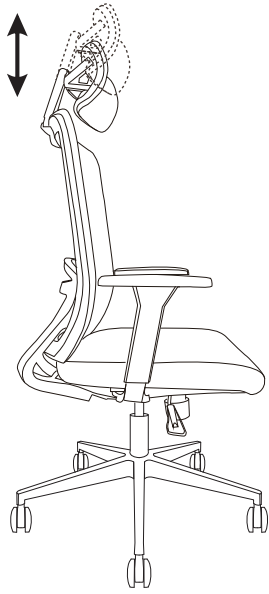

Lift the armrest button, the armrest can be adjusted up and down.

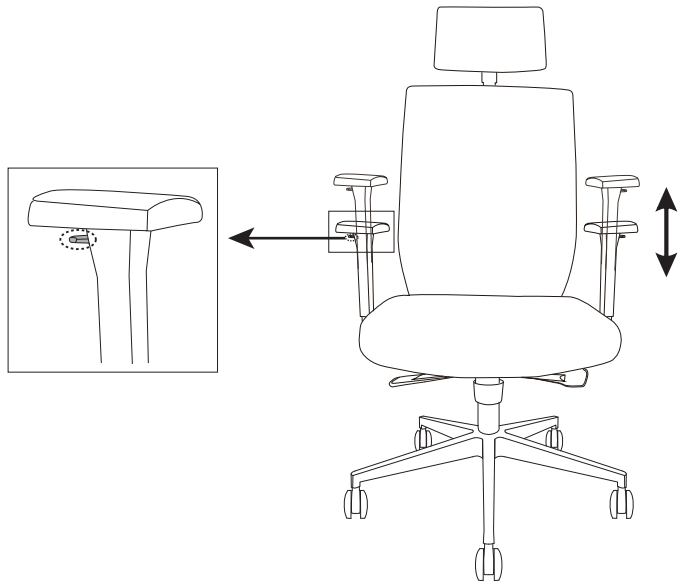

Lift the handle to adjust chair height.

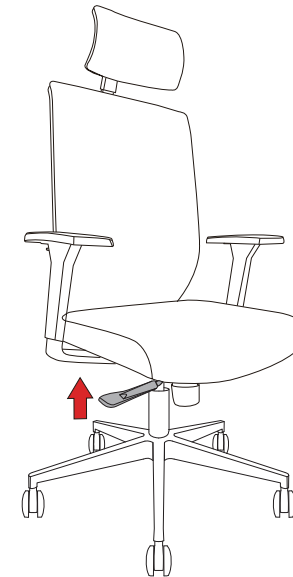

Push the handle forward to enable tilting, backward to lock. A total of 3 positions locking. Push the handle, lean back slightly and then reset.

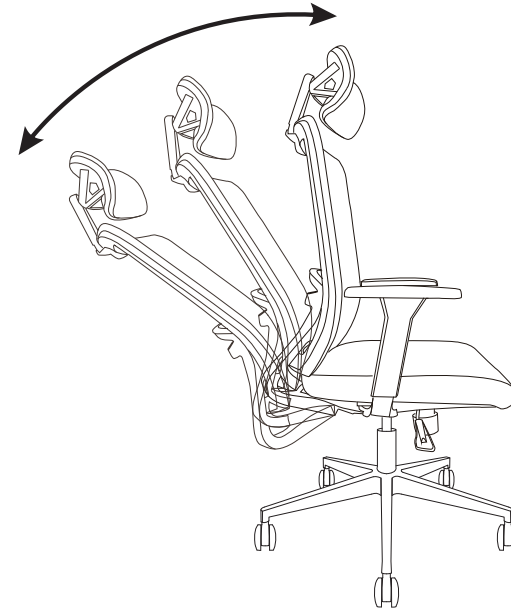
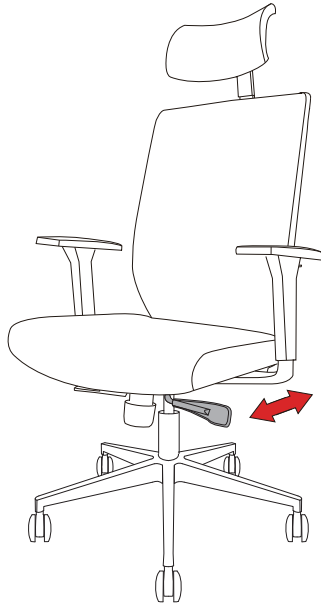

Rotate the knob to increase or reduce the tightness of chair back reclining.

